



# Hisense

## Air Conditioning

 **ConnectLife**



## Ducted Systems

### Whole Home Comfort



High Energy Efficiency



Self-Cleaning



HI-NANO



PCB with Insect Prevention



Wi-Fi Control



Geofencing

# 11 Good Reasons to Buy Hisense Air Conditioning



## 1. Global Air Con Experts

With over 50 years of global appliance manufacturing expertise and 35 years dedicated to air conditioning innovation, Hisense has established itself as a world leader in production and supply.

## 2. HI-NANO Air Purification Technology

Hisense HI-NANO outperforms standard plasma systems, generating 1 million ions/cm<sup>3</sup> to eliminate airborne bacteria within two hours. It efficiently removes allergens, mould, pollen, PM 2.5 particles, and odours, delivering fresher, cleaner air faster and more sustainably.

## 3. Self-Clean Technology

The Smart Self-Clean function enhances durability and efficiency by using an advanced frost and defrost cycle to keep your unit clean. By activating Self-Clean this avoids the unit spreading dust mould and other particles around. Enjoy superior air quality with minimal maintenance, just press a button and let the unit clean itself.

## 4. ConnectLife Smart Home

Your home, your life – smart, simple, connected. ConnectLife links home appliances across all Hisense brands, offering a unified Smart Home platform for effortless connectivity, simplifying daily tasks, and taking a step towards sustainability and enjoyment. With a simple touch or a voice command, ConnectLife transforms the way you interact with your home appliances.

## 5. Smart Features

- App Control: Adjust airflow, temperature, and monitor energy use anytime via the ConnectLife app.
- Voice Control: Hands-free convenience with Amazon Alexa and Google Home.
- Smart Mode: Automatically optimises settings for maximum comfort.

## 6. High Efficiency

Featuring 360° full DC inverter technology, an inner air duct, and an advanced louver fin design, Hisense air conditioners boost energy efficiency while reducing power consumption. Activate Eco Mode for up to 30% energy savings compared to older inverter models.

## 7. Bug-Preventative PCB Enclosure

To combat damage from small insects and geckos, Hisense outdoor units feature a sealed design that protects electrical components, preventing circuit board failures and enhancing durability.

## 8. Smart Operation

Built tough for Aussie conditions. Dependable heating, delivers consistent warmth even at -15°C. Unshaken by heat, the system effortlessly cools in extreme conditions, maintaining comfort up to 50°C. Solar ready, designed for energy-efficient, sustainable operations.

## 9. Durability

Hisense air conditioners feature an "Anti-Corrosive Golden Fin" on the outdoor units. Designed to withstand harsh weather conditions like salty air and rain, offering superior corrosion protection compared to standard fins. For a limited time, enjoy a 7-year warranty, giving you long-term peace of mind and reliable air conditioning you can trust.

## 10. Customer Care

Our dedicated customer care team is available 7 days a week, ready to support you whenever you need us. With nationwide coverage, we ensure fast, reliable assistance no matter where you are. Plus, we offer easy access to replacement and spare parts, so you can count on lasting performance and peace of mind.

## 11. Trusted Brand & Value

Hisense was awarded "Most Satisfied Customers – Air Conditioners 2024" by Australian consumers, reflecting our commitment to excellence. Hisense was rated highest overall across key areas such as value for money, features, quietness, and design.

Hisense Ducted Systems and HI-NANO technology are Sensitive Choice approved – a mark of trust for those who value cleaner air.

# Multi-Head Split Systems

A Multi-Head Split System is the ideal solution for spaces that require a variety of different individual indoor units in each room. With the flexibility to connect a single outdoor unit to 2, 3, 4, or even 5 indoor units including the wall-mounted, low static bulkhead duct.

See Multi brochure for more information.



# Cassette

Stay cool or warm at any time of the year using the functionality and accessibility of the Hisense C13.5kW H15.0kW 360° R32 Round Flow Ceiling Cassette with Wi-Fi (AUC-140UR4RNKC1). The perfect temperature for your room is always available using the 13.5kW cooling capacity and 15.0kW heating capacity. Combining exquisite design and intelligent technology to bring you fresh air and healthy living.

See Multi brochure for more information.



Visit [hisense.com.au](http://hisense.com.au) to explore our full product range.

Hisense

海信国际中心





Hisense is dedicated to providing high-quality air through cutting-edge air conditioning technologies.

With over 50 years of global appliance manufacturing experience and 35 years in air conditioning production, Hisense has become a world leader in manufacturing and supply.

Our unwavering commitment to crafting intelligent, durable products has propelled Hisense to the forefront of global distribution. Rooted in a philosophy of connectivity and convenience, we pioneer smarter technologies and solutions for modern living.

For over 25 years, Hisense has been at the forefront of inverter technology, ensuring our air conditioning systems deliver exceptional performance in both energy efficiency and cooling power. Engineered to withstand Australia's harsh and challenging climate, our products meet over 64 global quality standards, offering reliability and comfort in every season.

Hisense Ducted Systems and HI-NANO Air Purification Technology are officially Sensitive Choice approved a trusted symbol for those who care about cleaner, healthier air. Enjoy reliable performance and advanced purification that enhances indoor air quality and supports asthma and allergy management. Hisense Ducted Systems are the FIRST and ONLY in Australia to receive Sensitive Choice approval.

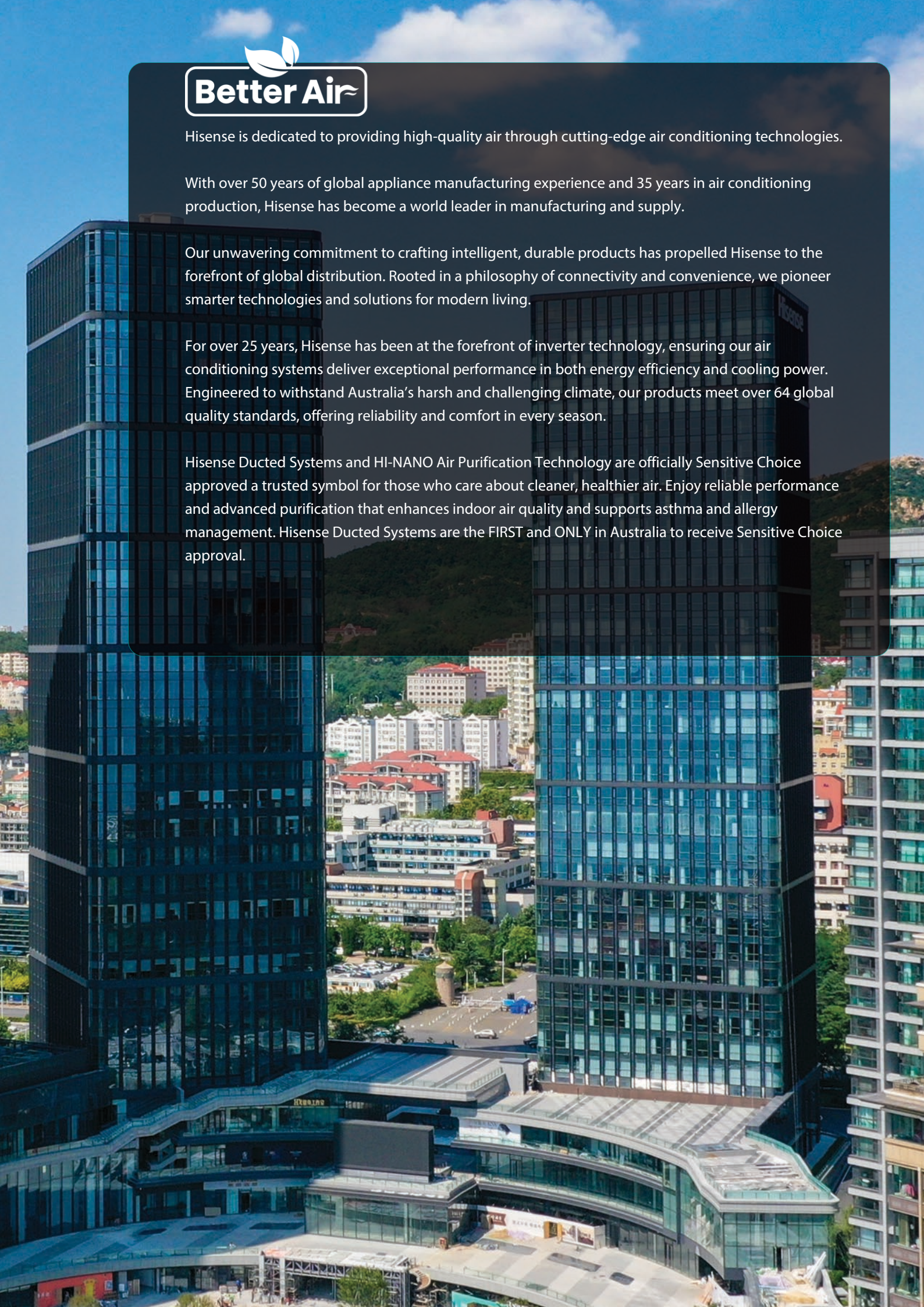

# Zone Control

## Up to 8 Zones

Zone Control gives you the flexibility to direct airflow to different areas of your home based on your daily routine. Instead of heating or cooling the entire house at once, you can choose to supply airflow only to the rooms being used. The system supports up to eight controllable zones, allowing for greater control over comfort and efficiency.





Adjusting airflow can significantly influence how quickly each space reaches a comfortable condition. For instance, airflow can be reduced or shut off to unused areas, helping the system work more effectively in active zones.

By limiting airflow to select areas, Zone Control reduces the load on your air conditioning system, which can lead to lower energy usage and help manage running costs. It's a practical way to enjoy comfort where and when it's needed most without unnecessary energy consumption.

Use airflow in the living room during the day, then redirect it to bedrooms in the evening. This smart adjustment aligns with your household's schedule and ensures your comfort is prioritised throughout the day.

# ConnectLife

## One-touch Control, Anytime, Anywhere

### Geofencing

Effortless comfort starts before you even walk through the door. Geofencing, available through the ConnectLife app, uses your phone's location to detect how far you are from home and automatically adjusts your air conditioning based on your movements.

You can easily set custom parameters allowing your system to turn on as you approach a certain distance from your home, ensuring the temperature begins adjusting before you arrive. For example, when you're 10 kilometres away, the unit can power on and start reaching your ideal comfort level for when you arrive home, no manual action required.

Geofencing also works when you leave the house. You can configure it to switch the unit off automatically once you're beyond a chosen range, giving you peace of mind and helping reduce unnecessary energy use.

Whether you're arriving to a home that's already perfectly cooled or heated, or leaving without needing to worry if the system is still running, Geofencing brings smarter, more convenient climate control to your daily routine. It takes the guesswork and ongoing decision-making out of managing your home's temperature, turning comfort into a preset, seamless experience.



### Auto Comfort Timers

Customise your comfort with unlimited daily timers to suit your lifestyle. Set your preferred mode, temperature, fan speed, and open zones, along with a start and end date for each setting. With just one setup, the system will operate automatically year-round, adapting to your routine throughout the day and night.

### Zone Control

Zones can be set up and adjusted directly through the ConnectLife app, giving you full control from your phone. You can activate or deactivate specific areas of the home, adjust airflow levels, and schedule zones to work alongside timers and Geofencing for a fully automated experience. This integration helps ensure each space is only conditioned when needed, improving both comfort and energy efficiency.

### Group Control

Group control allows you to combine multiple zones for quick, one-tap activation. Ideal for spaces you use often, like bedrooms or living areas, making it easy to manage comfort across multiple rooms at once.

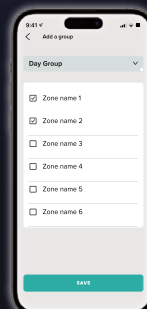



## Airflow Volume Control

The damper opening can be controlled with the ConnectLife App, and be moved in increments of 5%. Adjust air volume conveniently according to your lifestyle.



Open the living room damper when the family gathers.



Reduce the airflow during naps to maintain comfort without getting cold.

## Healthy Comfort HI-NANO

Activate HI-NANO mode remotely via the app helping eliminate airborne bacteria. Start it anytime, even when you're not at home, for cleaner, healthier air on demand.

## Energy Management Power Consumption Figures

Track real-time and historical power usage through the app. Activate Eco Mode to reduce energy use and save on running costs.

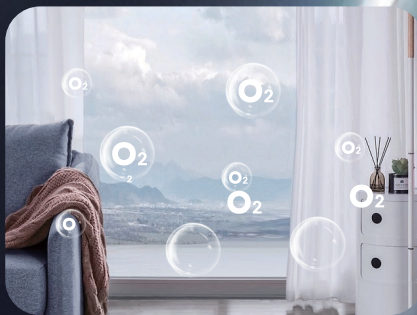

## Comfort That Matches Your Day

It's a winter morning and the temperature outside has dropped to 3°C. Inside, your home has cooled to 12°C overnight. You've scheduled your Hisense AC to start heating at 6am, aiming for 24°C. When you awake at 6:45 the house is already significantly warmer, making getting out of bed easier.

By 7am, the house is warm and comfortable. As you move through your routine, Zone Control adjusts automatically. The bedroom zone turns off, and heating shifts to the kitchen and living area where you're now active.

At 8am you leave without touching the system. Once you pass 1km from home, Geofencing powers off the unit, helping reduce energy use without manual input.

Later that afternoon, as you return <10km from home, the system switches back on, reheating the main living areas. When you arrive, the temperature is already back to your preferred setting.

That evening, zoning shifts again. The living areas power down, and the bedroom zone activates for the night. At 11pm, the system turns off via your scheduled timer.

Across the day, the system heats only where and when it's needed. With Zone Control, Timers and Geofencing, your home stays comfortable while reducing unnecessary energy use and the need for constant manual input.

# Smart Self-Cleaning



Hisense's patented Self-Clean technology helps maintain excellent air quality while reducing the need for regular manual cleaning. Over time, dust, mould, and other particles can build up inside an air conditioner, potentially recirculating into your living space and affecting the air you breathe. A dirty unit can push contaminants such as dust and bacteria throughout your home, diminishing air quality and contributing to an unhealthy indoor environment.

By activating the Self-Clean function, the system automatically performs a deep clean, helping to prevent the build-up of unwanted particles and reduce the spread of allergens through the air. This not only supports a cleaner home but also helps your unit operate more efficiently.

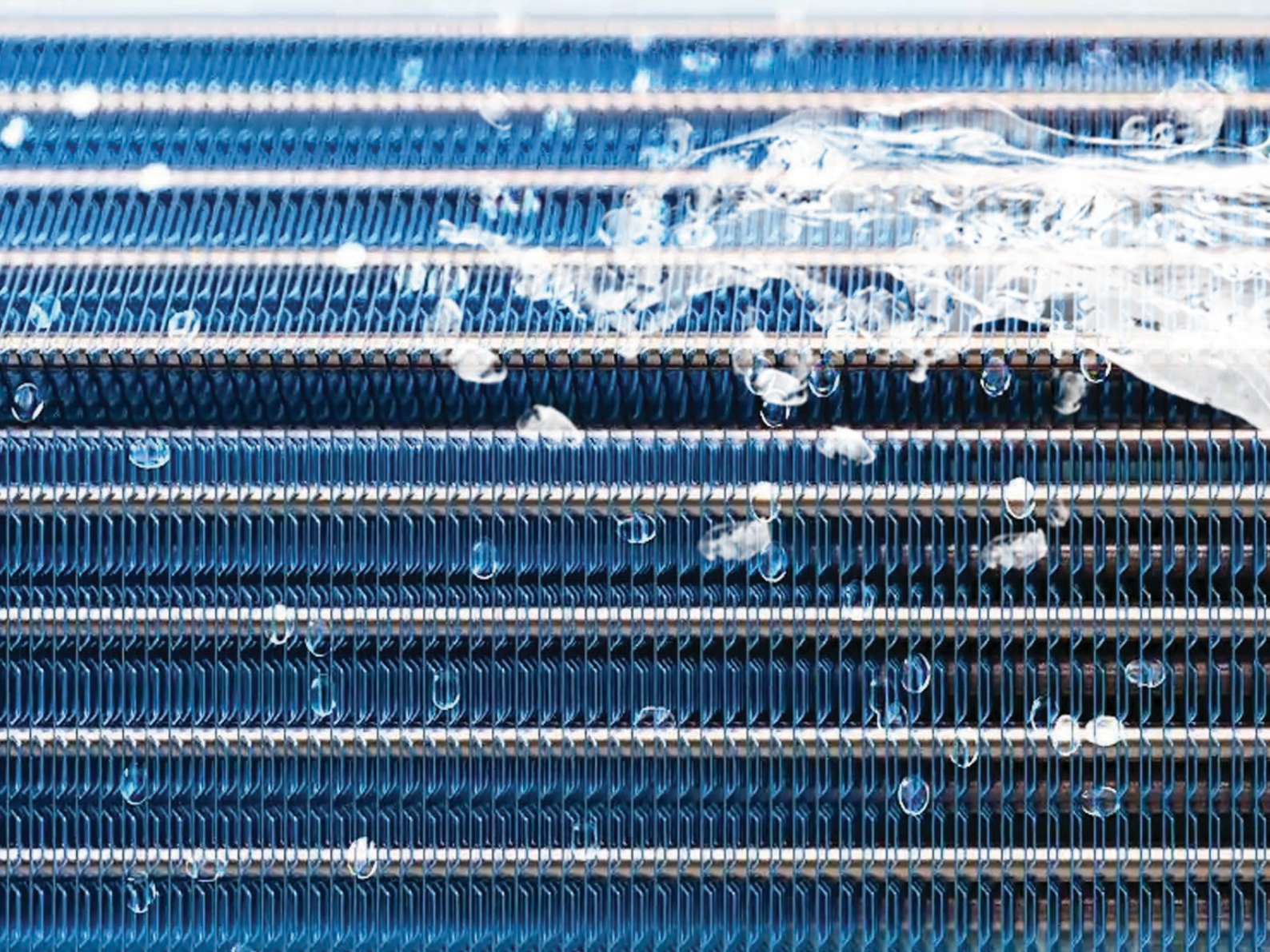

Frosting



Penetration

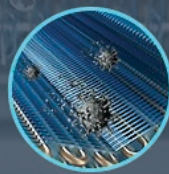

Stripping



Defrost

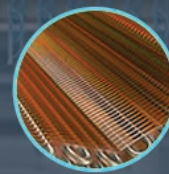

Drying

When an air conditioner is clogged with debris, it needs to work much harder to reach and maintain the desired temperature. This results in increased energy usage, longer runtimes, and unnecessary strain on the system, all of which can shorten the lifespan of the unit. Hisense Self-Clean technology is designed to reduce these impacts, keeping your system running at its best for longer.



Without Self-Clean, your AC coil can build up dust and nasties. Save money and keep it clean with the Hisense Self-Clean function.

# HI-NANO Technology



HI-NANO is an advanced and highly efficient plasma ion technology. Unlike ordinary plasma, which generates 0.4–0.6 million ions/cm<sup>3</sup>, HI-NANO produces an impressive 1 million ions/cm<sup>3</sup>. This increased ion density effectively eliminates airborne bacteria within just two hours of operation.

HI-NANO also excels at inhibiting a wide range of pollutants, including allergens, mould, pollen, PM 2.5, odours, and more. Compared to ordinary plasma, HI-NANO is more environmentally friendly and quickly removes pollutants, ensuring you can enjoy clean, fresh air every day.

HI-NANO releases high-concentration double ion groups to purify indoor air by:

- Removing 60.07% of PM2.5 particles.
- Eliminating 92.6% of H1N1 viruses.
- Inhibiting 88.5% of E. coli bacteria within 2 hours.

Hisense HI-NANO technology is officially Sensitive Choice approved, a mark of trust for those who value cleaner air. Hisense and Sensitive Choice are committed to providing Better Air for everyone, especially those living with asthma and allergies.

HI-NANO technology is globally certified.



**Hisense Ducted Air Conditioning Systems are proudly Australia's FIRST and ONLY ducted systems approved by Sensitive Choice.**

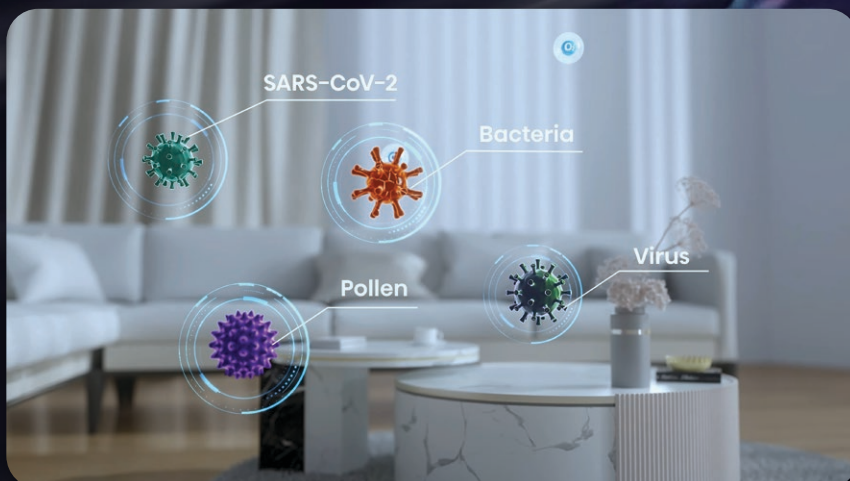

**For More Information on HI-NANO**

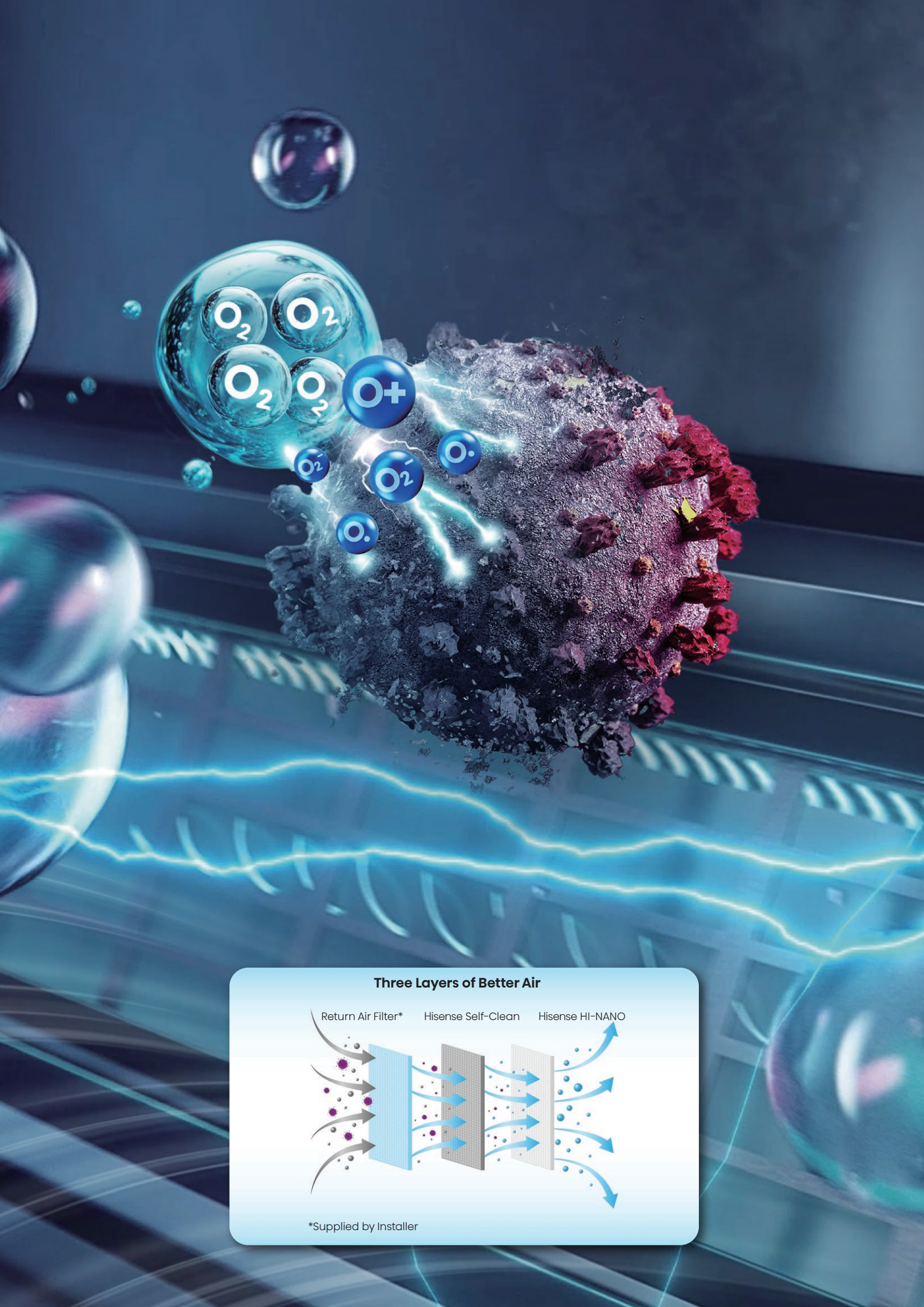

### Three Layers of Better Air

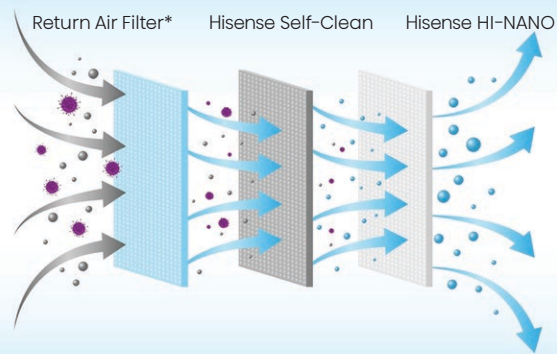

\*Supplied by Installer

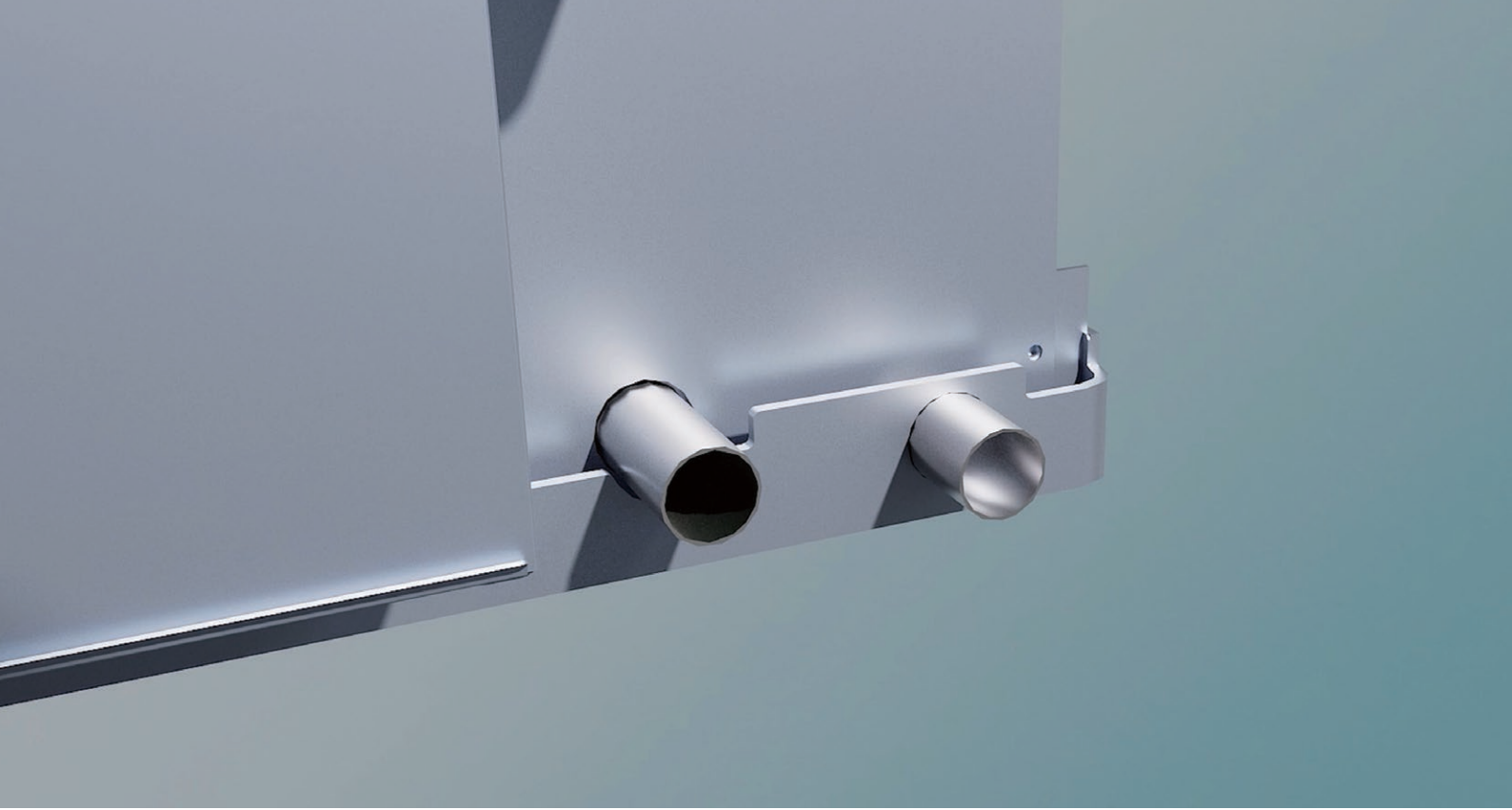

## Metal Drain Pan (Compact Ducted Only)

Our compact ducted design includes a built-in double drain pan, eliminating the need for installers to fit a secondary drain pan separately. This not only saves time and effort during installation but also reduces the risk of incorrect fitting, ensuring a more reliable and efficient drainage system. Both drain pipe outlets are positioned closely together, making it easy and convenient for installers to connect them to the same drainage path.



## Compact Ducted Outdoor Unit

The 8.5/10/12.5kW single fan outdoor unit design has a maximum height of only 840mm, offering flexibility to be placed either below a window or above a fence. Its compact size makes it easier to fit into tight spaces, reduces visual impact on the property, and allows for more versatile placement options to suit different home designs.



## Wide Voltage Operation

When voltage fluctuates between 176 V and 253 V, the air conditioner continues to operate reliably thanks to its unique voltage mutation self-adaptive technology.

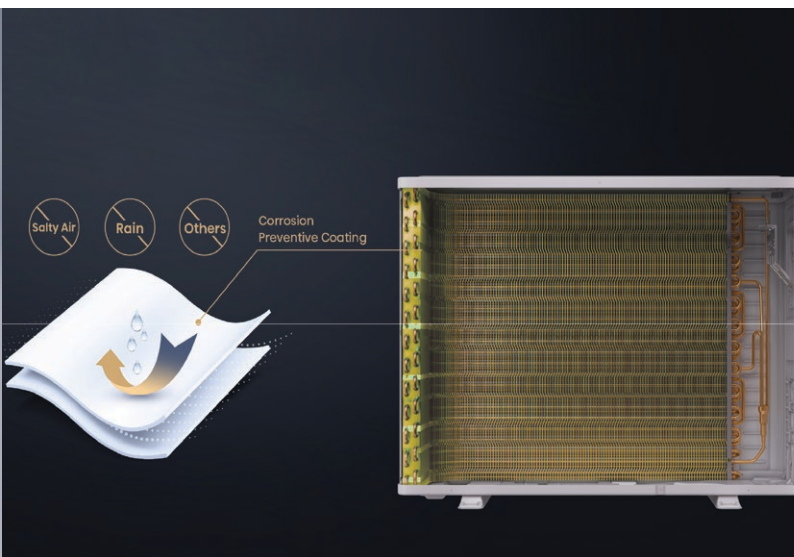

## Insect Prevention PCB

To prevent damage caused by small insects and geckos, Hisense outdoor units feature a sealed design that protects internal electrical components. This reduces the risk of circuit board failures caused by short circuits or corrosion and helps ensure stable, long-term operation. By minimising maintenance issues and extending the lifespan of the unit, this adds peace of mind for both homeowners and installers.

## Anti-Corrosion Golden Fin

The unique anti-corrosion golden fin offers superior durability against salty air, rain, and other corrosive elements. It provides:

- 3–4x more protection than standard fins.
- Enhanced hydrophilic properties for better heat exchange.
- A sleek, modern appearance for a premium aesthetic.
- Passed 1000hr anti-salt spray test.

# Reliable Outdoor Unit Performance

## Heating Focused Design Constant Comfort Air Conditioning

One advantage of Hisense inverter technology includes its ability to ensure precise temperature control and offer a wider power output range to perform in even the most extreme conditions in Australia ensuring constant comfort.

Cooling/Heating	LOW ROOM TEMP	MID ROOM TEMP	HIGH ROOM TEMP
Cooling	← 6KW		→ 17KW
Heating	← 18.5KW		→ 6KW

Graph shows each model's 12.5 kW High Static Ducted system's performance range during heating and cooling.

## Heating Focus Design

To suit cold climate conditions in Australia, the Hisense 12.5, 14, and 16 kW units feature a heating-focused system design. The outdoor unit uses Ø8 mm pipe diameters for heat exchange, compared to the Ø7 mm commonly used by competitors. This results in a 14% increase in heat exchange surface area, reduced pressure loss, significantly improved heating capacity and COP. The outcome is more powerful and efficient heating performance for the end user.



Heat Exchanging

## External Static Pressure Accurate Adjustment

The external static pressure can be easily adjusted via the wired controller, making setup more convenient and flexible. With precision control down to 1 Pa, it offers the most accurate external static pressure (ESP) settings in its class, ensuring optimal airflow is delivered consistently throughout the home.

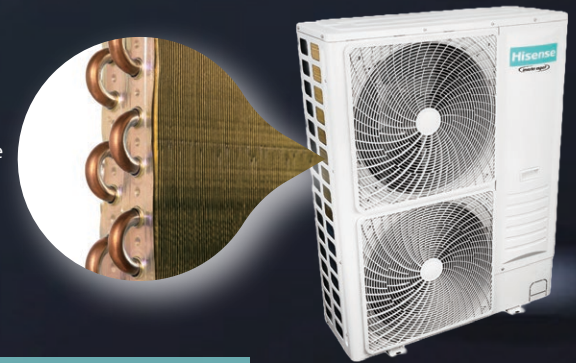

Conventional Adjustment



Static pressure step level

1Pa Adjustment



Adjustment precision of 1 Pa gives the most accurate ESP setting

## Full DC Inverter Energy Efficiency

The innovative 3D Inverter technology boosts energy efficiency by up to 25%.

## Advanced Comfort Control

Equipped with TMS technology, it automatically adjusts wind speed, temperature, and humidity to create an optimal and comfortable living environment.

By adopting independently developed inverter drive technology, the AC ensures more stable and efficient operations.

# A

## Full DC Inverter

Hisense expert inverter technology makes the unit more efficient, SEER/SCOP increased by 25%, energy saving 30%.

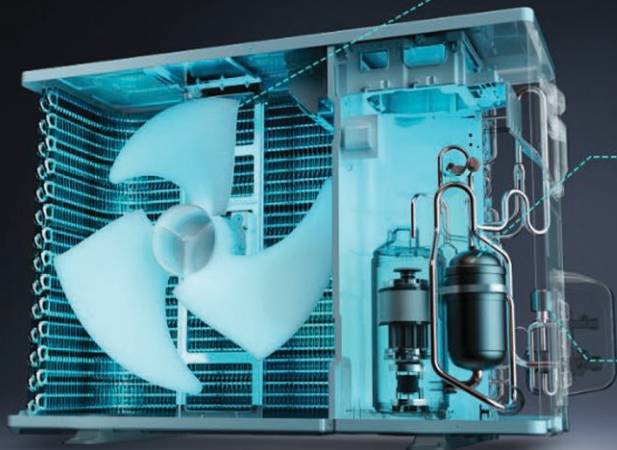

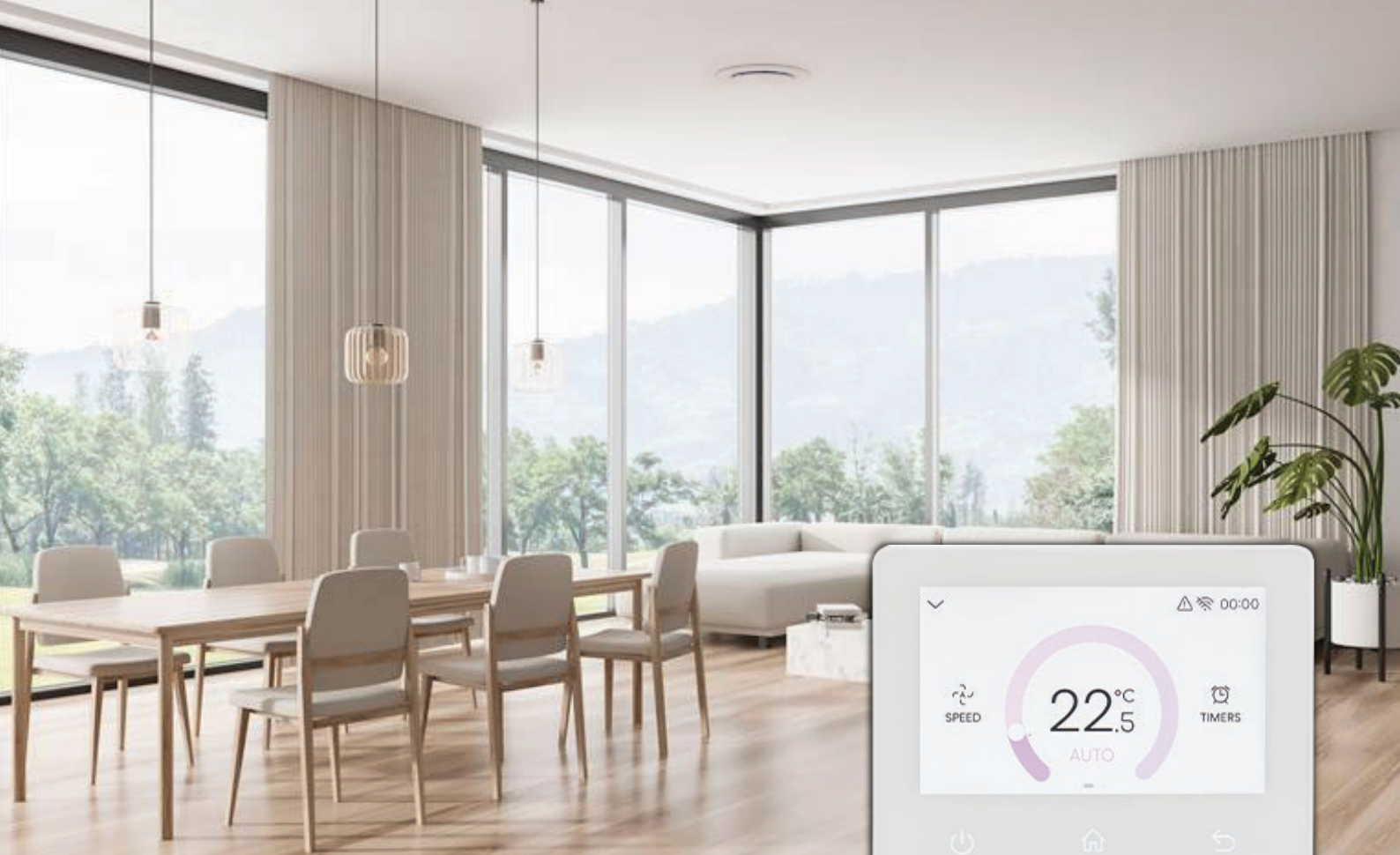

## Hi-Touch Controller



Smart zoned comfort, designed around you

### Airflow Volume Control

The system allows dampers to be adjusted in precise 5% increments, offering fine-tuned control over airflow. This enables more accurate comfort management across different areas of the home based on usage and individuals' preferences.

### Inbuilt Wi-Fi Module

The Hi-Touch Controller is equipped with an inbuilt Wi-Fi module, which can be conveniently utilised by a smart phone device. The Wi-Fi module within the controller enhances connection strength and helps reduce signal interruptions and dropouts.

Model Number	HACW02	HACZ01
Product Name	Standard Controller	Hi-Touch Controller (optional)
Product Picture		
Dimension (WxHxD)	120mm x 120mm*19mm	120mm x 120mm*17mm
Screen Dimension	3.2 inch	4.3 inch
Temperature Setting Range	16~30	
Power Supply	DC 12V	
Key Features	<ul style="list-style-type: none"> <li>•Same cable as the touch screen controller for easy upgrade</li> <li>•7-Day programmable</li> </ul>	<ul style="list-style-type: none"> <li>•Colour touch screen</li> <li>•Inbuilt Wi-Fi</li> <li>•Easy to use / easy make field settings</li> <li>•7-Day programmable</li> </ul>

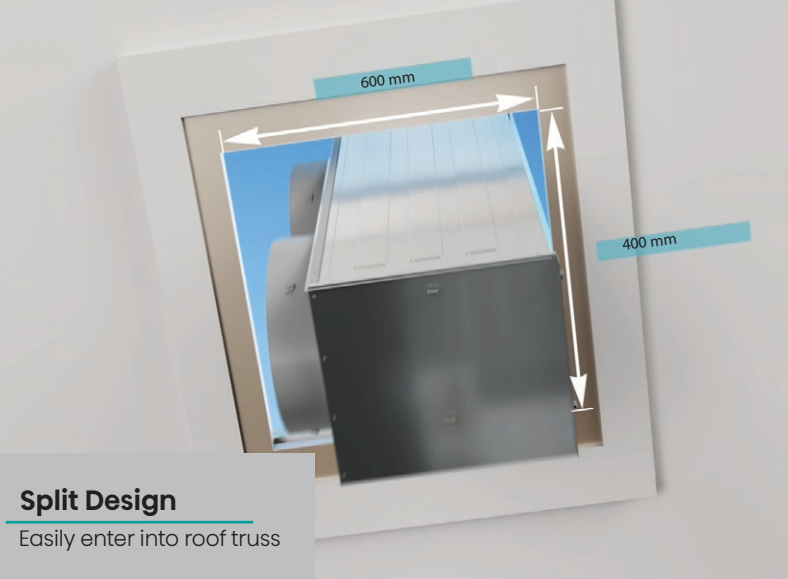

Experience the Difference with Our Premium Ducted Unit!

## Air Q Premium Ducted

Hisense Premium Ducted systems offer up to 75m piping between indoor and outdoor units, providing outstanding flexibility for larger homes and complex installs. A powerful High-Efficiency DC fan motor on the indoor unit delivers ultra-quiet, high-airflow performance for consistent comfort throughout the home. The indoor unit can also be split into two sections for easier positioning, reducing roof impact and streamlining installation.

Hisense's most powerful ducted unit yet, the new 18kW model is designed for large homes and demanding conditions. This single-phase system provides a straightforward replacement for traditional gas heating, supporting Australia's move toward cleaner, more efficient energy. Eligible homeowners can also access government rebates worth thousands under major energy programs.

Despite its power, the 18kW unit features the same compact coil design as the 16kW model. Smart engineering that delivers efficient performance, faster comfort, easier installation and quieter operation for both homeowners and installers.



43.5 kg  
Weight



Check Out Our Compact Ducted Unit in Action!

## Air Q Compact Ducted

Perfect for limited ceiling spaces, this indoor unit is engineered with a low-profile height of 398mm and a streamlined depth of 590mm.

Weighing just 43.5kg, it's light enough to handle with ease, helping to simplify installation in tight roof cavities or narrow ceiling voids. The unit can be passed through support timbers spaced 600mm apart, or vertically lifted with 400mm spacing, giving installers more flexibility in different ceiling structures.

This compact, efficient design makes it ideal for modern homes and renovations where ceiling clearance or access is restricted, without sacrificing functionality or performance.

# Air Q Premium Ducted

Indoor Unit Model		AUD-125UX4RSH1	AUD-140UX4RSH1	AUD-160UX4RSH1	AUD-180U4RSH1
Outdoor Unit Model		AUW-125U4RH1	AUW-140U4RH1	AUW-160U4RH1	AUW-180U4RZ1
Indoor picture					
Outdoor picture					
Rated capacity	Cooling(kW)	13.0	14.5	16.0	18.0
	Heating(kW)	15.5	17.0	18.9	21.0
Capacity range	Cooling(kW)	6.0~17.0	6.0-18.0	6.0~18.5	6.0~19.5
	Heating(kW)	6.0-18.5	6.0-19.5	6.0~20.0	6.0~23.5
Power input	Cooling(kW)	3.611	4.085	4.776	5.625
	Heating(kW)	3.780	4.250	4.870	5.530
EER/AEER	Cooling(kW/kW)	3.60/3.57	3.55/3.52	3.35/3.33	3.20/3.18
COP/ACOP	Heating(kW/kW)	4.10/4.06	4.00/3.97	3.88/3.85	3.80/3.77
TCSPF(residential)	Cold/average/hot	4.75/4.58/4.939	4.743/4.561/4.899	4.582/4.388/4.692	4.202/4.047/4.325
HSPF(residential)	Cold/average/hot	3.728/4.158/4.492	3.658/4.214/4.704	3.428/4.042/4.671	3.469/3.934/4.332
Airflow (H/M/L)	l/s	1020/810/710	1020/810/710	1120/920/780	1150/920/780
External static pressure	Pa	250	250	250	250
Indoor sound Level(H/M/L)	Sound pressure dB(A)@1.5m	56/53/49	56/53/49	58/55/51	58/55/51
Indoor dimension(h*w*d) (with PCB)	mm	360*1526*820			
Indoor packing dimension(h*w*d)	mm	440x1650x1055			
Supply air opening flange(H*W)	mm	245*1152			
Return air opening	mm	2*400 (Oval)			
Indoor net weight	kg	66.0			
Outdoor dimension(h*w*d)	mm	1460*975*330			1650*1100*390
Outdoor packing dimension(h*w*d)	mm	1590*1040*435			1810*1190*530
Outdoor net weight	kg	98.0			132.5
Power supply	V/Hz	1 phase,220-240V,50Hz			
Current	Cooling(A)	16.2	18.3	21.2	25.2
	Heating(A)	16.9	19.0	21.0	24.8
Maximum current (Rated current)	A	31.0	31.0	31.0	31.5
Liquid pipe diameter	mm	9.5(3/8) (flared)			
Gas pipe diameter	mm	15.9(5/8) (flared)			19.05 (3/4) (IDU: Weld ODU: Flared)
Drain	mm	ID 25/OD 32			
Max pipe length	m	75			
Max height drop	m	30			
Pre charge length	m	30			
Cooling temperature	°C	-10~50			
Heating temperature	°C	-15~24			
Outdoor sound level(H)	Sound power dB(A)	77			
	Sound pressure dB(A)@1m	62	62	62	66
Refrigerant	Type	R32			

# Air Q Premium Ducted

## Basic



### Auto

Auto mode can be activated using either the wired controller or ConnectLife. When set, the unit automatically controls fan speed and powers the unit on/off to reach desired temperature.



### Cool

Cooling mode can be activated using either the wired controller or ConnectLife App.



### Wide Operating Range

Reliable heating in outdoor temperatures as low as -15 °C, and effortless cooling even in extreme heat up to 50 °C. Built to handle tough Aus conditions.



### 7 Year Warranty

Experience long-term reliability with our 7-year warranty, giving you confidence that your ducted system is built to last. Terms and conditions apply.



### Fan

Fan mode can be activated using either the wired controller or ConnectLife App.



### Dry

Dehumidifying mode can be activated using either the wired controller or ConnectLife App.



### Hot

Heating mode can be activated using either the wired controller or ConnectLife App.



### Rebate Friendly

Our ducted units are eligible for Australian Government rebates. Check your state's requirements for eligibility.

## Comfort



### Anti-Cold Air

Prevents the cold air from blowing out during heating mode. Once the heating function is turned on, enjoy warmth immediately.



### Faster Cooling

Achieve fast cooling with a high running frequency compressor, powerful fan, advanced air duct and heat-exchange system.



### Self-Cleaning (Indoor Unit)

Patented technology helps maintain air quality while reducing the need for regular manual cleaning. The system performs a deep clean preventing the build-up of unwanted particles the spread of allergens.



### Zone Control

Flexibility to direct airflow to different areas of the home based upon daily routine. Allows up to 8 individual climate zones with one indoor unit.



### Quiet Mode

Set the unit to quiet mode to help reduce noise especially when trying to sleep.



### HI-NANO Purification

HI-NANO outperforms standard plasma systems, generating 1 million ions/cm<sup>3</sup> to eliminate airborne bacteria within two hours. It efficiently removes allergens, mold, pollen, PM 2.5 particles.

## Efficiency



### Insect Prevention PCB

Outdoor units feature a sealed design that protects electrical components, reducing the risk of circuit board failures caused by short circuits or corrosions.



### I FEEL

The remote control is equipped with a temperature sensor to feel 1 meter within the surrounding temperature.



### Solid Plastic Drain Pan

Built-in solid plastic drain pan, significantly more durable than the commonly used foam pan.



### Full DC Inverter

Advanced inverter technology makes Hisense the inverter expert. Better energy efficiency with external motor drive technology.



### High Efficiency DC Compressor

Twin rotary compressor results in less noise and vibration.



### Anti-Corrosion Golden Fin

Superior durability against salty air, rain, and other corrosive elements. Golden Fin boasts 3-4x More Protection than standard fins.

## Flexible



### Duct Static Pressure Setting

Adjustable ESP setting via the wired controller. The precision of 1 Pa adjustments give the most accurate ESP setting in class.



### Demand Response Capable

If subscribed to your states program this allows your electricity provider to adjust AC power use during peak times. This helps ease pressure on the grid while keeping comfort in mind.



### Noise Control

By setting DIP, this can reduce the noise of the ODU operation.



### Long Pipe Control

Up to 75m of pipe can connect the IDU'S and ODU, granting higher installation flexibility.



### Hi-Checker

The AC can connect to Hi-Checker to monitor the product parameters, including discharge temperature, indoor coil temperature, outdoor coil temperature, etc.



### Splittable Indoor Unit

The indoor unit can be split into two sections for easier positioning and connection during installation. This minimises roof impact and simplifies the installation process.

## Smart



### Intelligent Defrost

The optimised defrosting logic ensures better heating capacity and faster defrosting.



### Auto Restart

The unit automatically returns to the last active settings after power failure.



### Group Control

Combine multiple zones for quick, one tap activation. Ideal for frequently used areas like bedrooms or living areas making it easy to manage comfort across multiple rooms at once.



### Hi-Touch Controller With Wi-Fi

Built-in Wi-Fi module in the controller for better connection. Premium coloured touchscreen controller for easy operations.



### Child Lock

Prevents accidental changes to settings by locking the controls. This ensures the unit continues to operate as intended without unintended adjustments.



### Energy Consumption Monitor

Allows users to track power usage directly through the ConnectLife app. This helps provide clear insights into energy use for smarter management.



### Error Code Display

Error code can be identified through the panel display. When there is an error, the error code will flash. Making it easier for service agents to troubleshoot.



### Energy Saving Technology

3D Inverter improves energy efficiency by up to 25%, while smart ConnectLife features further optimise usage to reduce running costs.



### Filter Cleaning Reminder

When the AC runs for an extended period, it provides a reminder to clean the filter. This helps maintain performance and efficiency.



### Airflow Volume Control

Dampers can be adjusted in precise 5% increments, giving fine-tuned control over airflow. Allowing for more precise comfort control.



### Timers

Unlimited daily timers to suit your lifestyle. Set your preferred mode, temperature, fan speed, open zones along with a start and end date.



### ConnectLife App

Users can activate Geofencing, HI-NANO Mode, Self-Cleaning, timers and airflow volume settings, while also monitoring unit performance, energy consumption and managing other Hisense appliances.



### Low Pressure Protection

The outdoor unit is equipped with a low-voltage switch to ensure the product reliably operates during low voltage fluctuations.



### High Heating Performance

Unit uses Ø8 mm pipe diameters over the Ø7 mm frequently used by competitors giving a 14% larger heat exchange surface area, reduced pressure loss, and significantly improved heating capacity and COP.



### Voice Control



When the unit is connected to Wi-Fi, you can control the aircon by voice via Amazon Alexa or Google Home speakers.



### Leakage Detection

The AC can detect and alert you to refrigerant leaks by monitoring abnormal parameters.

# Air Q Compact Ducted

Indoor Model		AUD-85UX4RTH1	AUD-100UX4RTH1	AUD-125UX4RTH1
Outdoor Model		AUW-85U4RK1	AUW-100U4RK1	AUW-125U4RQ1
Indoor picture				
Outdoor picture				
Rated capacity	Cooling(kW)	8.5	10.0	12.3
	Heating(kW)	10.0	11.0	14.0
Capacity range	Cooling(kW)	4.1~11.0	4.1~11.0	4.2~13.4
	Heating(kW)	3.8~11.5	3.8~11.5	3.3~15.6
Power input	Cooling(kW)	2.66	3.13	3.98
	Heating(kW)	3.03	3.33	4.24
EER/AEER	Cooling(kW/kW)	3.2/3.18	3.2/3.18	3.09/3.07
COP/ACOP	Heating(kW/kW)	3.3/3.28	3.3/3.28	3.3/3.28
TCSPF(residential)	Cold/average/hot	4.529/4.312/4.601	4.51/4.293/4.562	4.138/3.971/4.22
HSPF(residential)	Cold/average/hot	3.163/3.638/4.164	2.899/3.408/4.409	3.039/3.637/4.383
Airflow (H/M/L)	l/s	750/610/528	750/610/528	875/700/612
External static pressure	Pa	200	200	200
Indoor sound Level(H/M/L)	Sound pressure dB(A)@1.5m	54/48/45	54/48/45	55/49/46
Indoor dimension(h*w*d) (with PCB)	mm	398×1256×500		
Indoor packing dimension(h*w*d)	mm	420×1331×650		
Supply air opening flange(W*H)	mm	952*295		
Return air opening flange(W*H)	mm	962*324		
Indoor net weight	kg	43.5		
Outdoor dimension(h*w*d)	mm	750*900*340		835*975*360
Outdoor packing dimension(h*w*d)	mm	820*1060*450		960*1045*460
Outdoor net weight	kg	57.5		73.0
Power supply	V/Hz	1 phase,220-240V,50Hz		
Current	Cooling(A)	11.9	14.0	17.7
	Heating(A)	13.6	14.9	18.8
Maximum current (Rated current)	A	19.0	19.0	26.5
Liquid pipe diameter	mm	9.5(3/8) (flared)		
Gas pipe diameter	mm	15.9(5/8) (flared)		
Drain	mm	ID 20/OD 26		
Max pipe length	m	50	50	50
Max height drop	m	30	30	30
Pre charge length	m	20	20	20
Cooling temperature	°C	-10-46	-10-46	-10-50
Heating temperature	°C	-15-24	-15-24	-15-24
Outdoor sound level(H)	Sound power dB(A)	67	67	76
	Sound pressure dB(A)@1m	60	60	62
Refrigerant	Type	R32		

# Air Q Compact Ducted

## Basic



### Auto

Auto mode can be activated using either the wired controller or ConnectLife. When set, the unit automatically controls fan speed and powers the unit on/off to reach desired temperature.



### Cool

Cooling mode can be activated using either the wired controller or ConnectLife App.



### Wide Operating Range

Reliable heating in outdoor temperatures as low as -15 °C, and effortless cooling even in extreme heat up to 50 °C. Built to handle tough Aus conditions.



### 7 Year Warranty

Experience long-term reliability with our 7-year warranty, giving you confidence that your ducted system is built to last. Terms and conditions apply.



### Fan

Fan mode can be activated using either the wired controller or ConnectLife App.



### Dry

Dehumidifying mode can be activated using either the wired controller or ConnectLife App.



### Hot

Heating mode can be activated using either the wired controller or ConnectLife App.



### Rebate Friendly

Our ducted units are eligible for Australian Government rebates. Check your state's requirements for eligibility.

## Comfort



### Anti-Cold Air

Prevents the cold air from blowing out during air conditioning heating mode. Once the heating function is turned on, enjoy warmth immediately.



### Faster Cooling

Achieve fast cooling with a high running frequency compressor, powerful fan, advanced air duct and heat-exchange system.



### Self-Cleaning (Indoor Unit)

Patented Self-Cleaning technology helps maintain air quality while reducing the need for regular manual cleaning. The system performs a deep clean preventing the build-up of unwanted particles the spread of allergens.



### Zone Control

Flexibility to direct airflow to different areas of the home based upon daily routine. Allows up to 8 individual climate zones with one indoor unit.



### Quiet Mode

Set the unit to quiet mode to help reduce noise especially when trying to sleep.



### HI-NANO Purification

HI-NANO outperforms standard plasma systems, generating 1 million ions/cm<sup>3</sup> to eliminate airborne bacteria within two hours. It efficiently removes allergens, mold, pollen, PM 2.5 particles.

## Efficiency



### Insect Prevention PCB

Outdoor units feature a sealed design that protects electrical components, reducing the risk of circuit board failures caused by short circuits or corrosions.



### I FEEL

The remote control is equipped with a temperature sensor to feel 1 meter within the surrounding temperature.



### Metal Drain Pan

Built-in metal drain pan, significantly more durable than the commonly used foam pan.



### Full DC Inverter

Advanced inverter technology makes Hisense the inverter expert. Better energy efficiency with external motor drive technology.



### High Efficiency DC Compressor

Twin rotary compressor results in less noise and vibration.



### Anti-Corrosion Golden Fin

Superior durability against salty air, rain, and other corrosive elements. Golden Fin boasts 3-4x More Protection than standard fins.

## Flexible



### Duct Static Pressure Setting

Adjustable ESP setting via the wired controller. The precision of 1 Pa adjustments give the most accurate ESP setting in class.



### Demand Response Capable

If subscribed to your states program this allows your electricity provider to adjust AC power use during peak times. This helps ease pressure on the grid while keeping comfort in mind.



### Noise Control (12.5kW Unit Only)

By setting DIP, this can reduce the noise of the ODU operation.



### Long Pipe Control

Up to 50m of pipe can connect the IDU'S and ODU, granting higher installation flexibility.



### Hi-Checker

The AC can connect to Hi-Checker to monitor the product parameters, including discharge temperature, indoor coil temperature, outdoor coil temperature, etc.



### Compact Indoor Unit

Compact efficient design makes it ideal for modern homes and renovations where ceiling clearance or access is restricted, without sacrificing functionality or performance.

## Smart



### Intelligent Defrost

The optimised defrosting logic ensures better heating capacity and faster defrosting.



### Auto Restart

The unit automatically returns to the last active settings after power failure.



### Group Control

Combine multiple zones for quick, one tap activation. Ideal for frequently used areas like bedrooms or living areas making it easy to manage comfort across multiple rooms at once.



### Standard Controller

Easy to use controller with wireless signal receiver. Optional Hi-Touch controller upgrade, with built in Wi-Fi.



### Child Lock

Prevents accidental changes to settings by locking the controls. This ensures the unit continues to operate as intended without unintended adjustments.



### Energy Consumption Monitor

Allows users to track power usage directly through the ConnectLife app. This helps provide clear insights into energy use for smarter management.



### Error Code Display

Error code can be identified through the panel display. When there is an error, the error code will flash. Making it easier for service agents to troubleshoot.



### Energy Saving Technology

3D Inverter improves energy efficiency by up to 25%, while smart ConnectLife features further optimise usage to reduce running costs.



### Filter Cleaning Reminder

When the AC runs for an extended period, it provides a reminder to clean the filter. This helps maintain performance and efficiency.



### Airflow Volume Control

Dampers can be adjusted in precise 5% increments, giving fine-tuned control over airflow. Allowing for more precise comfort control.



### Timers

Unlimited daily timers to suit your lifestyle. Set your preferred mode, temperature, fan speed, open zones along with a start and end date.



### ConnectLife App

Users can activate Geofencing, HI-NANO Mode, Self-Cleaning, timers and airflow volume settings, while also monitoring unit performance, energy consumption and managing other Hisense appliances.



### Low Pressure Protection (12.5kW Unit Only)

The outdoor unit is equipped with a low-voltage switch to ensure the product reliably operates during low voltage fluctuations.



### High Heating Performance

Unit uses Ø8 mm pipe diameters over the Ø7 mm frequently used by competitors giving a 14% larger heat exchange surface area, reduced pressure loss, and significantly improved heating capacity and COP.



### Voice Control

When the unit is connected to Wi-Fi, you can control the aircon by voice via Amazon Alexa or Google Home speakers.



### Leakage Detection

The AC can detect and alert you to refrigerant leaks by monitoring abnormal parameters.

# Hisense

Just makes sense

---

Hisense Australia Pty., Ltd.  
Level 1/37 Dalmore Dr, Scoresby VIC 3179  
hisense.com.au

Customer Support  
Email: hvacorders@hisense.com  
Phone: 1800 447 367

Note: Product design and specification subject to change without prior notice.  
© 2024 Hisense Corporation. All rights reserved. Hisense the Hisense logo and the Just Makes Sense logo are trademarks or registered trademarks of Hisense Group in China and/or other countries. All rights reserved. All other company names, brand names, trademarks and logos are the property of their respective owners. All rights reserved.